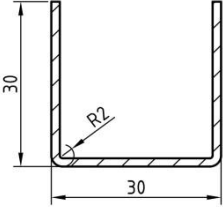
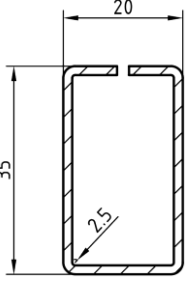
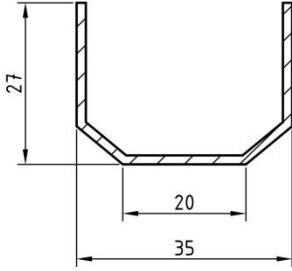
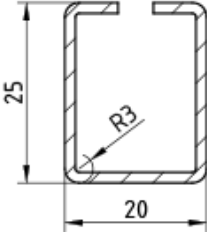
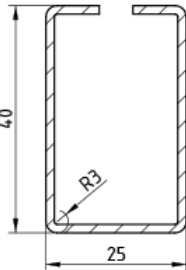
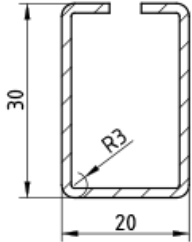
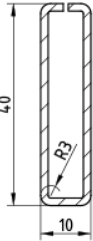
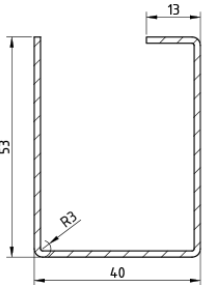
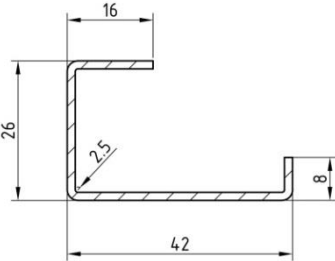
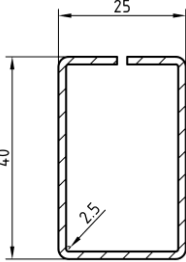
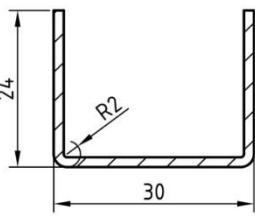
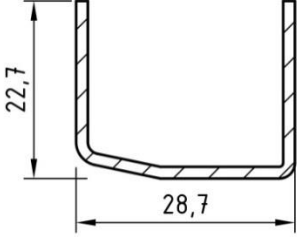
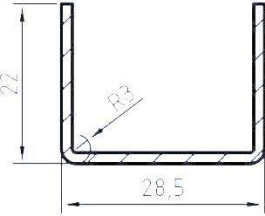
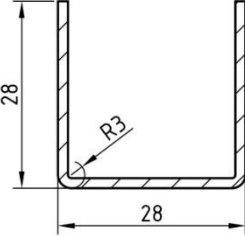
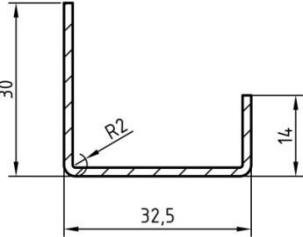
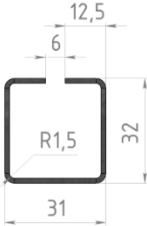
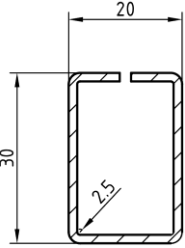
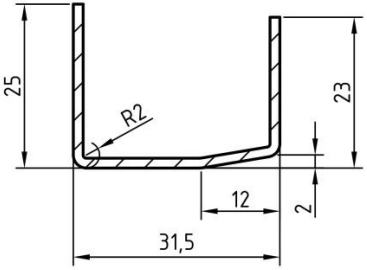
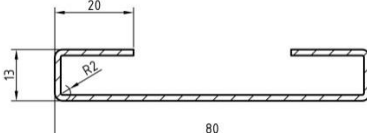
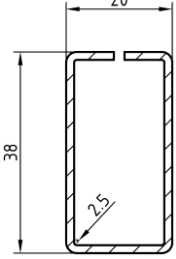
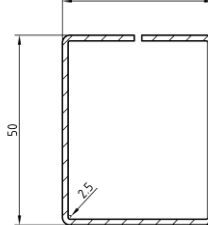
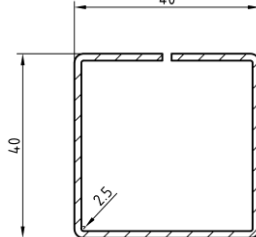
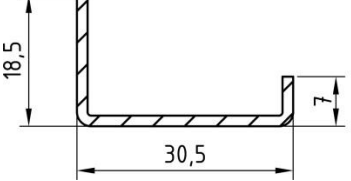

Galvanised steel reinforcement sections for the PVC-u window and door
TU BY 692 127 934.001–2019

No	Drawing	Type	Analogue
1		30x30	ALUPLAST 229001
2		20x35	ALUPLAST 229101
3		35x27	ALUPLAST 229023
4		20x25	ARtec S 15-15
5		25x40	ARtec S 21

6		20x30	ARtec S 3-15
7		10x40	ARtec S 20
8		53x40x13	ARtec S 66
9		42x26	BRUGMANN VS-102
10		25x40	BRUGMANN VS-302
11		30x24	DEXEN

12		28,7x22,7	Gealan 3705
13		28,5x22	Gealan 879 251
14		28x28	Gealan 871 551
15		14x32,5x30,5	KBE-200
16		31x32	KBE-201
17		20x30	KBE-203

18		31,5x25x23	KBE-207
19		80x13x15	KBE-208
20		20x38	KBE-604
21		40x50	KBE 614
22		40x40	KBE 655
23		31,5x18x7	LIDER

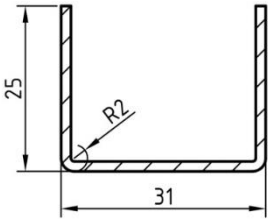
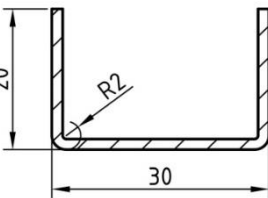
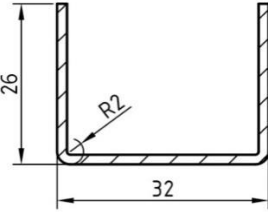
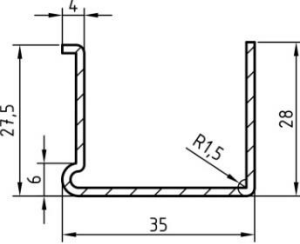
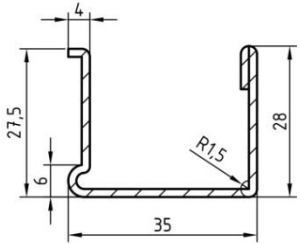
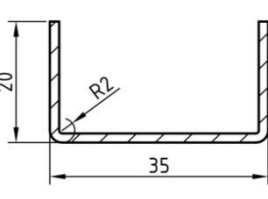
24		31x25	Montblanc
25		30x20	Montblanc Logick
26		32x26	Montblanc
27		35x28x27,5	Rehau 506
28		35x28x27,5	Rehau 506
29		35x20	Rehau 245536

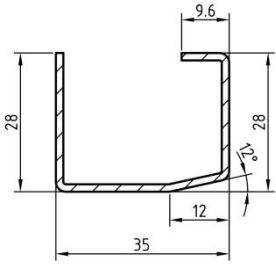
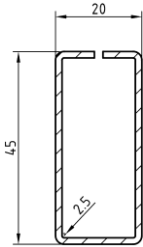
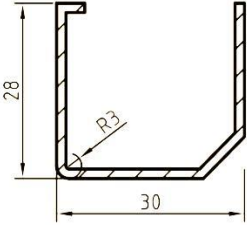
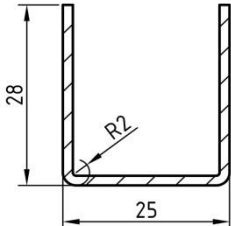
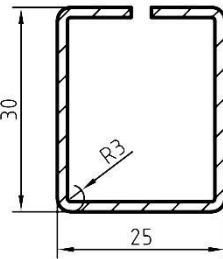
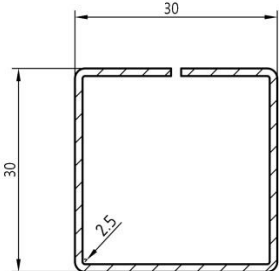
30		35x28x28	Salamander 455210
31		20x45	Salamander 215120
32		30x28	Salamander 215025
33		25x28	VEKA 113.060
34		25x30	VEKA 113.002
35		30x30	VEKA 113.025

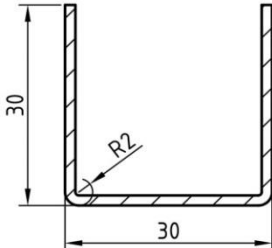
36	 <p>The diagram shows an L-shaped profile with a vertical leg of height 30 and a horizontal leg of width 30. The inner corner is rounded with a fillet radius labeled R2. The profile is shown with hatching to indicate its thickness.</p>	30x30	VEKA 113.3655
----	--	-------	---------------